

1,000 GALLON 1-C TRAFFIC RATED TANK

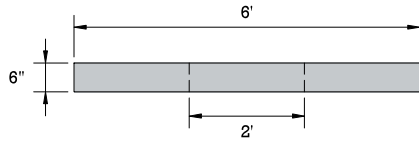

FRONT VIEW - TOP



SIDE VIEW - TOP

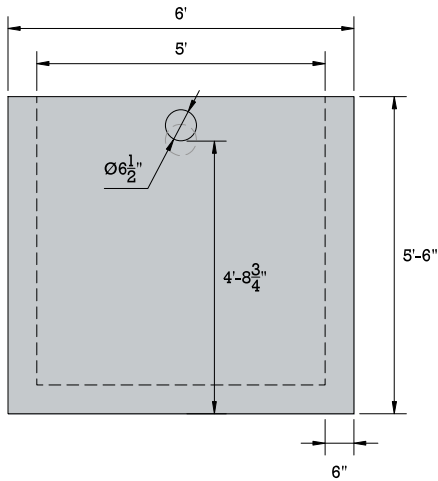

FRONT VIEW

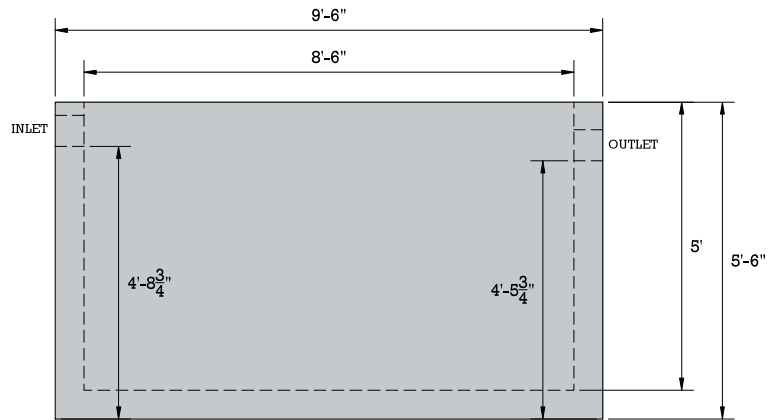

SIDE VIEW

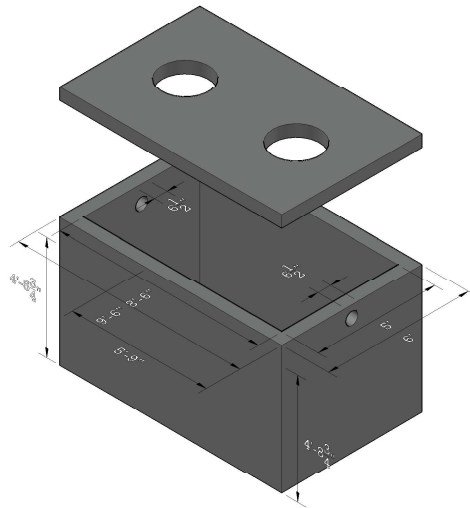

ISOMETRIC VIEW

SIZE	WEIGHT (LBS)	SPECIFICATIONS
	16,650	Concrete: 4000PSI @ 28 days
		Reinforcement: ASTM A615/A615M GRADE 60 ASTM A1064/A1064M-16B
		<ul style="list-style-type: none"> The tank is a monolithic pour (no mid seams). Top Slab is sealed with prostick mastic. The tank is designed to meet HS 20-44 loading requirements. Reinforced lid - has optional PA inspection port. Reinforced risers are available. 3 optional inlets and 1 outlet location.

