

6-PACK PULL BOX

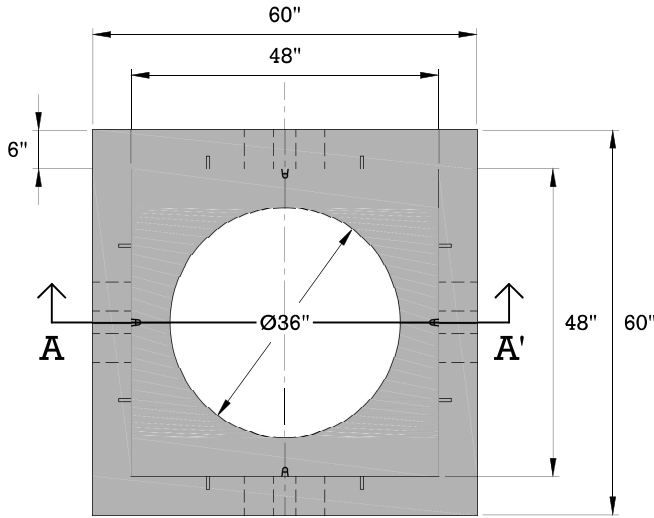

PLAN VIEW

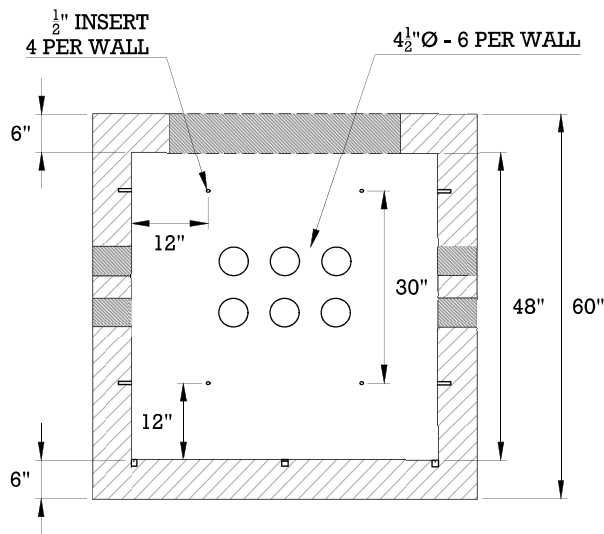
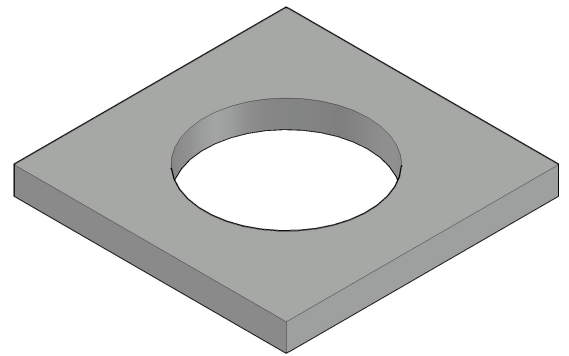

SECTION A-A'

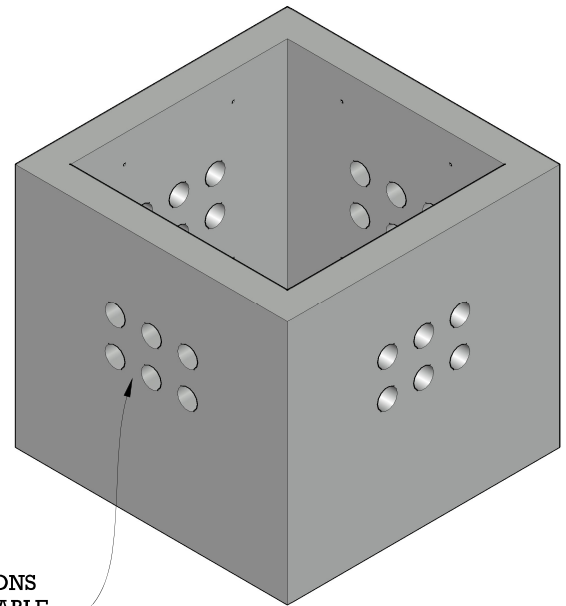

HOLE LOCATIONS
ARE CUSTOMIZABLE

ISOMETRIC VIEW

SIZE	WEIGHT (LBS)	SPECIFICATIONS
	6,850	Concrete: 4000PSI @ 28 days
		Reinforcement: ASTM A615/A615M GRADE 60 ASTM A1064/A1064M-16B
		<ul style="list-style-type: none"> The tank is a monolithic pour (no mid seams). Top Slab is sealed with prostick mastic. The tank is designed to meet HS 20-44 loading requirements. Reinforced lid - has optional PA inspection port. Reinforced risers are available. 3 optional inlets and 1 outlet location.

