

12' T-WALL

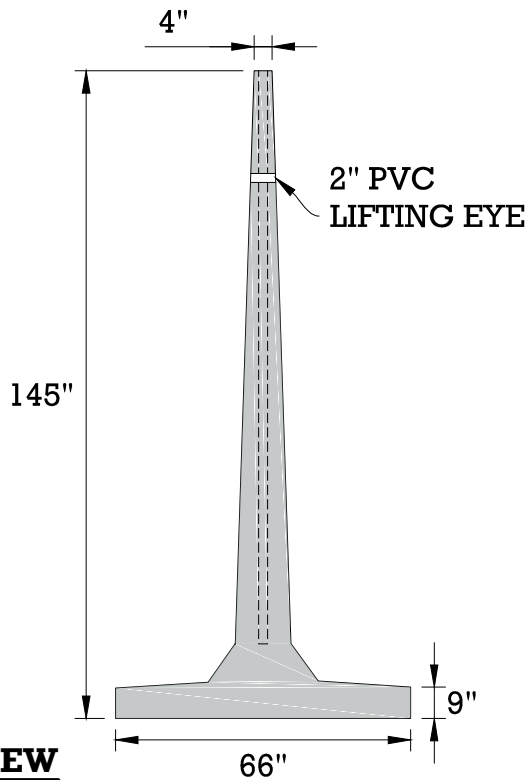

	WEIGHT (LBS)	SPECIFICATIONS
	7,550	Concrete: 4000PSI @ 28 days
		Reinforcement: ASTM A615/A615M GRADE 60 ASTM A1064/A1064M-16B

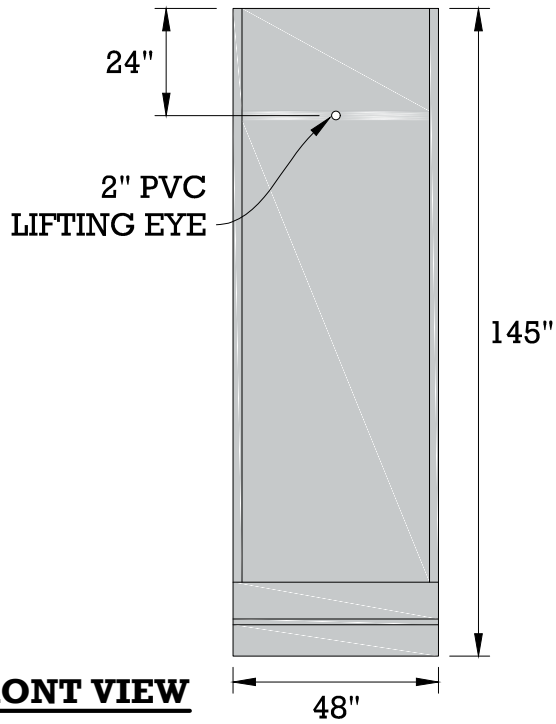